



8ARD deep crepe lens, DC-2S end plug & LSS-3 stainless steel latches shown.

## Description

The Sentry<sup>®</sup> series is A.L.P.'s flagship gasketed enclosure. The Gear Tray type combines cost effectiveness with functional practicality by minimizing required internal metal components versus Strip Type enclosures. The Sentry housing is sealed against dust and moisture and available in a variety of lens, latch, wire-entry, and lamp configurations.

## Applications

Ideal for use in dusty, dirty, or wet environments including food processing, cold storage, kitchens, parking garages, car washes, covered canopies, pedestrian tunnels, concourses, and industrial.

For applications where the temperatures may exceed 80° C, A.L.P. recommends the use of stainless steel traylats. (i.e. three lamp/row fixtures)

## Certifications

- UL/cUL recognized component
- Wet Location listed
- NSF International certified for NSF/ANSI Standard 2 – Food Equipment

## Features

- Rigid one piece housing construction.
- En-seal<sup>™</sup> gasketing provides superior resistance to moisture absorption versus conventional gasketing.
- Lens retained by twelve suitcase style latches.
- Molded latch pockets compatible with standard and tamper-proof latches in stainless steel and polycarbonate.
- Internal gear tray mounts to #10-32 brass stud molded into housing by two plastic or steel Traylats.
- Gear tray suspends from housing by two security straps during servicing.

## Housing

Compression molded self-extinguishing fiberglass reinforced polyester compound with UL 5V flame rating (ASTM D635-74). F1 weatherability rating.

## Gasketing

En-Seal<sup>™</sup> continuous perimeter poured gasket assures lens seal to housing.

## Electrical Chassis

Gear trays constructed of 83% reflective, 22-gauge, pre-painted steel.

## Conduit Entry

Standard housings available with one 7/8" conduit entry point on either or both ends. Consult Sales for other opening sizes or for top openings.

## Lens

Thermoformed lenses available in tapered, shallow and deep profiles of crepe pattern acrylic or DR reinforced acrylic.

## Mounting

Standard stainless steel bracket (BRKTS22PK) for surface or all-thread pendant mounting. Consult sales for chain or cable mounting options.

A.L.P. submitted this fixture for wet location testing in the horizontal surface mounted position. Any other operating position should be test verified by the OEM.

Please contact A.L.P. for pricing and delivery.

All specifications subject to change without notice. A.L.P. assumes no responsibility for these materials in any luminaire or application.

The product is an OEM component kit requiring final assembly by a qualified OEM fixture manufacturer.

Sealant required for wet location use.

### EXPLODED VIEWS

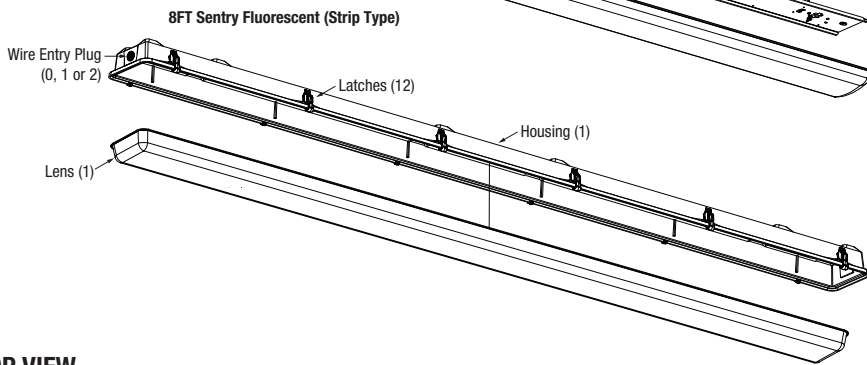
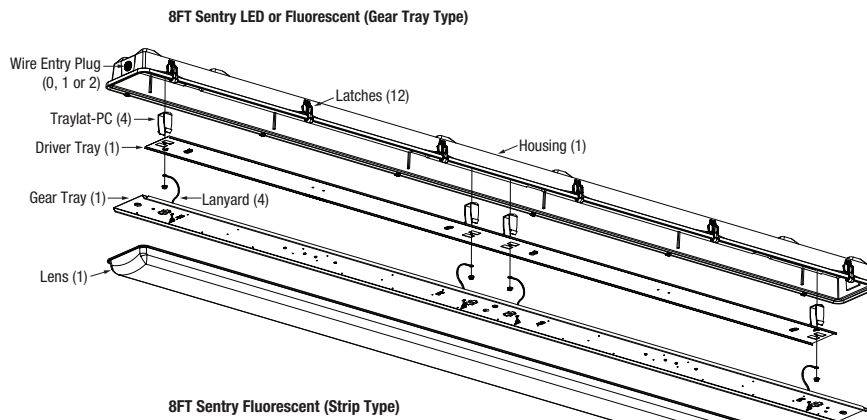

### TOP VIEW

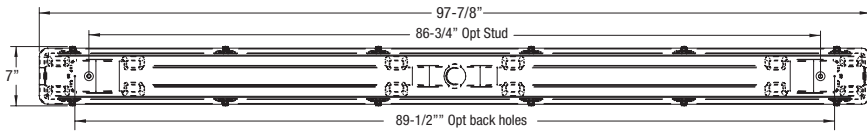

### SIDE VIEW



### END VIEWS

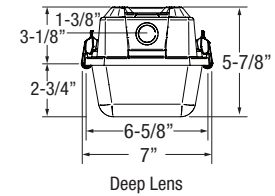
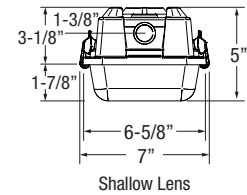
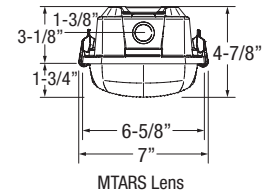

HOUSING (Select One)		
Part Number	Description	Qty/Case
8F-2-GT	8FT Gear Tray Type 5VA Housing (2 end holes)	30
8F-2-GTBS	8FT Gear Tray Type 5VA Housing, w/Backstuds (2 end holes)	30
GEAR TRAY (Select one)		
Part Number	Description	Qty/Case
SENTRYGT8U	8' Sentry gear tray T5, T8 and T12 (To customize, submit gear tray blank dwg/model with details)	80
DRIVER TRAY		
Part Number	Description	Qty/Case
SENTDT8-LED	8FT LED Driver Tray	75
LENS (Select one)		
Part Number	Description	Qty/Case
8MTARS100F	8FT Tapered Lens, AC 100% Frost	30
8MTARSHI	8FT Tapered Lens, AC/HI-IMPACT	30
8MTARSMI	8FT Tapered Lens, AC/MED IMPACT	30
8ARS00	8FT Shallow Lens, AC/HI-IMPACT	30
8ARS15	8FT Shallow Lens, AC MED-IMPACT Crepe Pattern	30
8ARD00	8FT Deep Lens, AC/HI-IMPACT, Crepe Pattern	30
8ARD15	8FT Deep Lens, AC/MED IMPACT, Crepe Pattern	30
LATCHES (Select twelve)		
Part Number	Description	
LPC	White polycarbonate latch	
LPCTP3	Tamper-proof white polycarbonate latch with nut and screw	
LSS-3	Stainless steel latch	
LSS-3TP	Tamper-proof stainless steel latch with nut and screw	
WIRE ENTRY PLUGS (Select two)		
Part Number	Description	
FEPW	White 7/8" dry location plug	
LTP088*	White 7/8" liquid tight plug	
DC-2S*	7/8" die cast aluminum fitting assembly for 1/2" rigid conduit	
HOUSING MOUNTING BRACKET (Select Four)		
Part Number	Description	Qty/Case
BRKTS22PK	Sentry stainless steel strap bracket, 2-pack	80
MISCELLANEOUS PARTS		
Part Number	Description	
TRAYLAT-PC	White polycarbonate gear tray mounting clip (NUT1001 Required)	
TRAYLATSS**	Stainless steel gear tray mounting clip (NUT1001 Required)	
LANYARD	White nylon security strap	
NUT1001	#10-32x3/8" steel hex locking nut for TRAYLAT attachment to housing	
SC8GND	#8-32x3/8" green ground screw	
OPTIONAL ACCESSORIES		
Part Number	Description	
TAMPER BIT 3	Driver bit for TAMPERPRUF screw used in LPCTP3 & LSS-3TP	
TAMPER BIT 8	Driver bit for tamper-proof snake eye drive screw, compatible with LSS-3	

\* Sealant required for wet location use.

\*\*A.L.P. recommends using TRAYLATSS for three lamp fixtures.

#### GEAR TRAYS

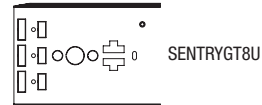

#### LATCHES

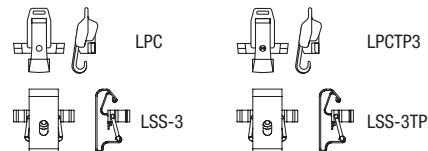

#### WIRE ENTRY PLUGS



#### LENSES



#### HOUSING MOUNTING BRACKETS

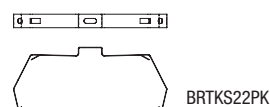

#### MISCELLANEOUS PARTS

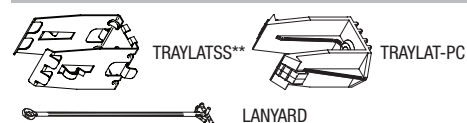

#### OPTIONAL ACCESSORIES



KITS		
Kit Number	Description	Qty/Case
F296-2	Sentry 8ft strip type kit (without gear tray)	1
Kit Includes		Qty/Kit
8F-2	8ft Sentry housing two holes	1
8ARS15	8ft Sentry AC/Shallow/CR/85-15	1
FEPW	Flush white end plugs	2
LPC	White polycarbonate latch	12

KITS		
Kit Number	Description	Qty/Case
F296-2-GT	Sentry 8ft gear tray kit (with tube type gear tray)	1
Kit Includes		Qty/Kit
8F-2-GT	8ft Sentry housing two holes	1
8MTARSMI	8' Sentry MTARS 85/15 ACR	1
SENTRYGT8U	Sentry 8ft gear tray universal T5 T8 and T12	1
FEPW	Flush white end plugs	2
LPC	White polycarbonate latch	12
LANYARD	White nylon security strap	2
TRAYLAT-PC	White polycarbonate gear tray mounting clip	2

ASSEMBLY		
Part Number	Description	Qty/Case
TBD	Custom quote only. Customer must supply boards and drivers.	1

### EXPLODED VIEWS

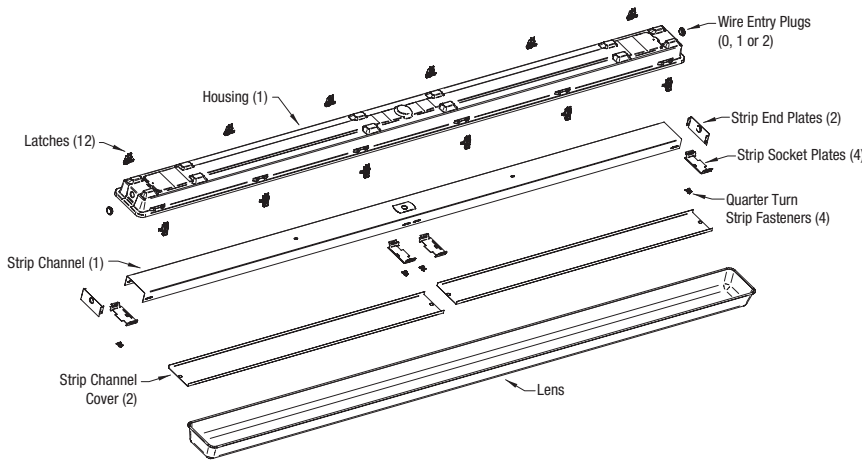

### END VIEWS

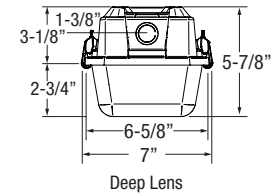
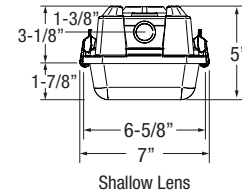
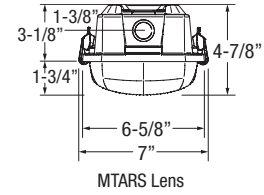

### TOP VIEW

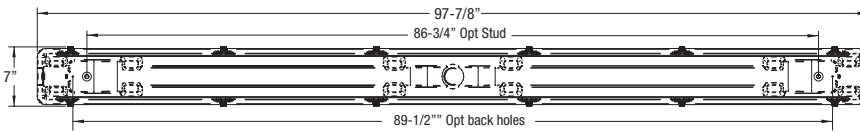

### SIDE VIEW



HOUSING (Select One)		
Part Number	Description	Qty/Case
8F-0	8FT Strip Type HB Housing (no end holes)	30
8F-2	8FT Strip Type HB Housing (two end holes)	30
OPTIONAL STRIP HOUSING COMPONENTS		
Part Number	Description	Qty/Case
SEP296B	8' Striplight channel (Select One) †	250
SEP240C-VP	4' Striplight T8 channel cover (Select Two)	500
SEP240C-T5	4' Striplight T5 channel cover (Select Two)	500
SEP140SP	1-Lamp T8 socket plate (Select Four for tandem lamps)	500
SEP240SP	2-Lamp T8 socket plate (Select Four for tandem lamps) †	500
SEP340SP	3-Lamp T8 socket plate (Select Four for tandem lamps)	500
SEPS1L4T5	1-Lamp T5/T5HO socket plate (Select Four for tandem lamps)	250
SEPS2L4T5	2-Lamp T5/T5HO socket plate (Select Four for tandem lamps)	250
SEPS3L4T5	3-Lamp T5/T5HO socket plate (Select Four for tandem lamps)	250
SEPE	Striplight end plates (Select Two) †	500
RQTF	¼-Turn fastener for striplight channel cover (Select Four) †	2500
SEP240TANVP	8' 2-Lamp tandem T8 Striplight channel kit. Contains items marked with †	n/a

For All Other Options Please Refer to Page 3

Note: Strip housing components are purchased through A.L.P. Steel craft.