



4SNGPG50 parking garage lens, DC-2S die cast end plug and LSS-5 stainless steel latches shown.

Description

Sentry Elite® LED combines the benefits of LED technology with the features OEMs have come to rely upon in the flagship Sentry series. Sentry Elite LED utilizes gear tray internal construction for cost effectiveness and functional practicality by minimizing required internal metal components. Drivers mount to the driver tray for thermal isolation. The Sentry Elite housing is sealed against dust and moisture and available in a variety of lens, latch, and wire-entry configurations. Suitable with use @ 40° C ambient using up to a 60W source.

NOTE: All certifications noted below are contingent upon construction and configuration. Please contact an A.L.P. Engineer for further assistance.

Certifications

- UL/cUL recognized component
- Wet Location listed
- IP65, IP66 and IP67
- IP69K Rated using 4SNGPG50 and 4SNGPGPC lenses
- NSF International certified for NSF/ANSI Standard 2 – Food Equipment

Applications

Ideal for use in dusty, dirty, or wet environments including food processing, cold storage, kitchens, parking garages, car washes, covered canopies, pedestrian tunnels, concourses, and industrial.

Features

- Rigid one piece housing construction.
- Two 1/4-28 brass studs molded into back of housing for attachment of optional mounting brackets.
- En-seal™ gasketing provides superior resistance to moisture absorption versus conventional gasketing.
- Lens retained by eight captive flush mounted latches.
- Molded latch pockets compatible with standard and tamper-proof latches in white polycarbonate and stainless steel.
- Gear trays secured to #10-32 brass studs molded into housing via threaded hex steel mounting standoffs.
- LED Module tray available for four rows of nominal 22" LED boards.
- LED Module tray suspends from housing by two security straps during servicing.

Fixture Performance for Reference Only

(See photometry)

Driver	LGITDRV48WX048A (1)
LED Module	LGITLED-1-28-40K (4)
4686.3 lm, 48.567W, 96.5lm/W	

Housing

Compression molded self-extinguishing fiberglass reinforced polyester compound with UL 5VA flame rating (ASTM D635-74). F1 weatherability rating.

Gasketing

En-Seal™ continuous perimeter poured gasket assures lens seal to housing.

Electrical Chassis

Gear trays constructed of minimum 83% reflective, 22-gauge, pre-painted steel.

Conduit Entry

Standard housings available with one 7/8" conduit entry point on either or both ends. Consult Sales for other opening sizes or for top openings.

Lens

Inline thermoformed low profile lenses available in 50% DR acrylic in clear, crepe and Lumieo. Lenses for parking garage applications available in 50% DR clear acrylic, polycarbonate and Lumieo.

Mounting

Standard 316 stainless steel straps (SBRKT-SNG-2PK) for surface mounting, or optional flush mounting bracket, serves as a mounting point for either a snap-in-place mount or a hook. Consult A.L.P. Sales for cable mounting options.

A.L.P. submitted this fixture for wet location testing in the horizontal surface mounted position. Any other operating position should be test verified by the OEM.

Please contact A.L.P. for pricing and delivery.

All specifications subject to change without notice. A.L.P. assumes no responsibility for these materials in any luminaire or application.

The product is an OEM component kit requiring final assembly by a qualified OEM fixture manufacturer.

Sealant required for wet location use.

Exploded View Parking Garage Type

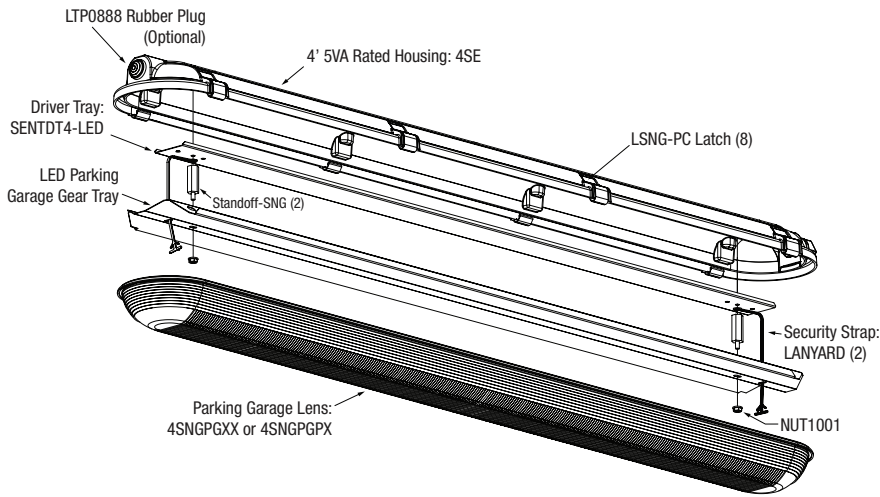

Dimensions Parking Garage Type

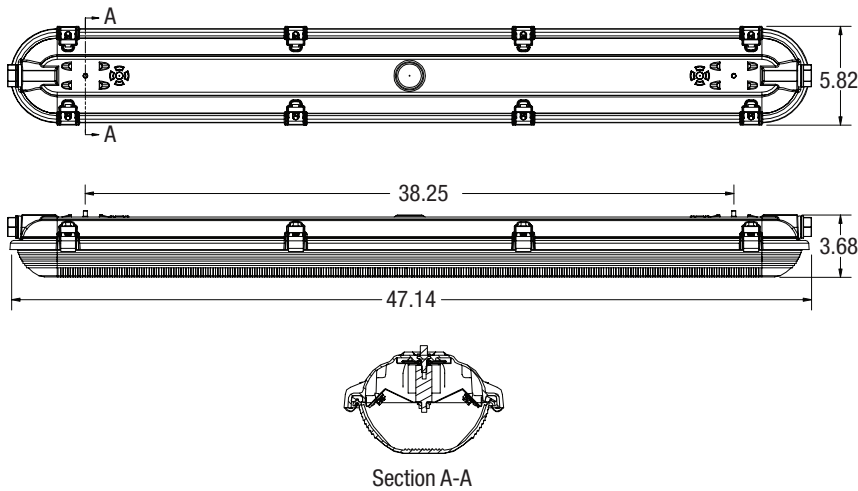

Fixture Performance for Reference Only (See photometry)

Sentry Elite 4' Parking Garage Kit	
Specification	4' Sentry
Input Wattage	48.56
Delivered Lumens (lms)	4686.3
Efficacy (LpW)	96.5
Voltage (V)	120-277v
Operating Frequency (Hz)	50/60

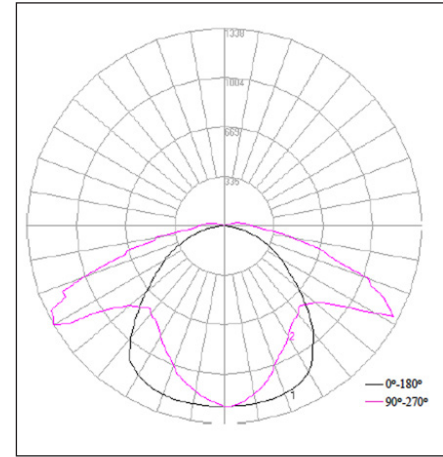

Notice

A.L.P. assumes no responsibility for suitability of these materials in any luminaire or application. Please test for fit and function prior to ordering project quantities.

While A.L.P. utilizes IESNA testing procedures and believes our testing results to be accurate, A.L.P. provides photometry for reference only. Actual results will vary based on the actual light source(s) and power source(s) used, i.e. ballast, driver, generator, etc. and the combinations in which they are used, as well as operating temperatures, and other electrical and environmental variables. We urge that customers perform their own fixture qualifications prior to making performance-based claims. In no event will A.L.P. be liable for any loss or damage, including without limitation, indirect or consequential loss or damage in connection with the use of this information.



Exploded View Low Profile Type

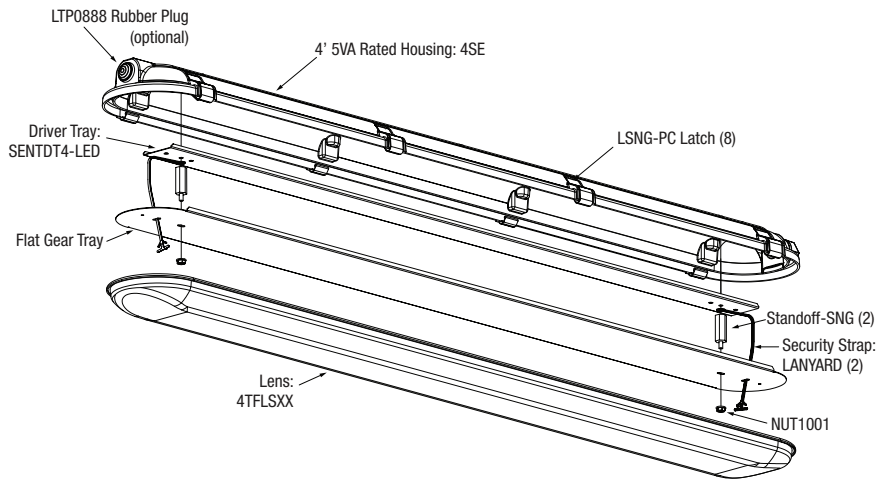

Dimensions Low Bay Type

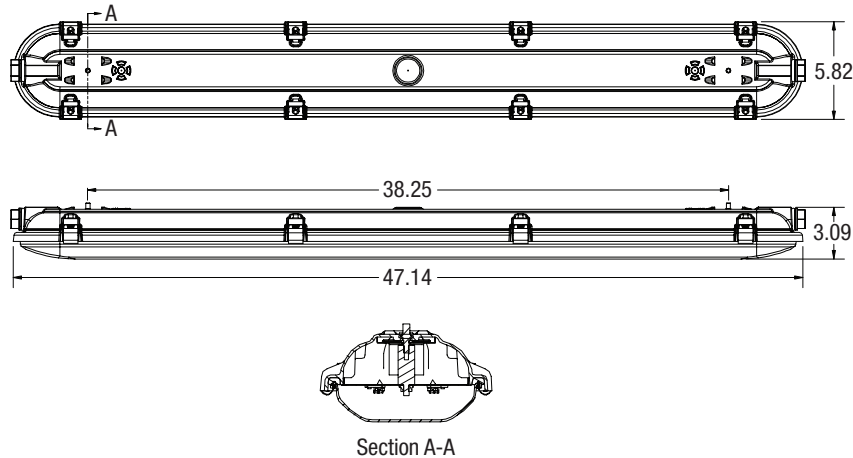

Fixture Performance for Reference Only (See photometry)

Sentry Elite 4' Flat Gear tray Kit	
Specification	4' Sentry
Input Wattage	48.70
Delivered Lumens (lms)	4807.1
Efficacy (LpW)	98.71
Voltage (V)	120-277v
Operating Frequency (Hz)	50/60

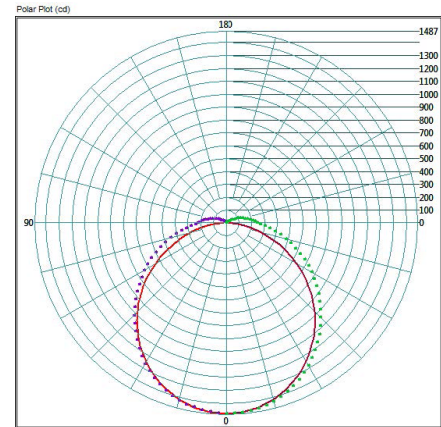

Notice

A.L.P. assumes no responsibility for suitability of these materials in any luminaire or application. Please test for fit and function prior to ordering project quantities.

While A.L.P. utilizes IESNA testing procedures and believes our testing results to be accurate, A.L.P. provides photometry for reference only. Actual results will vary based on the actual light source(s) and power source(s) used, i.e. ballast, driver, generator, etc. and the combinations in which they are used, as well as operating temperatures, and other electrical and environmental variables. We urge that customers perform their own fixture qualifications prior to making performance-based claims. In no event will A.L.P. be liable for any loss or damage, including without limitation, indirect or consequential loss or damage in connection with the use of this information.

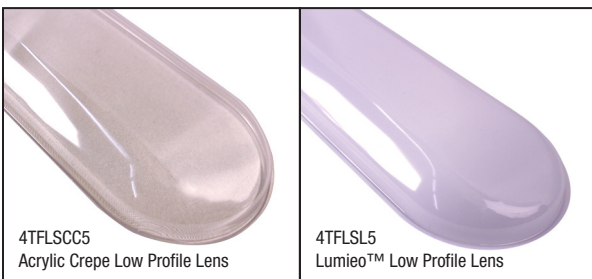

HOUSING		
Part Number	Description	Packaging
4SE-1	4' Sentry Elite housing 1 hole, 7/8"	35 pcs carton; 140 pcs pallet
4SE-2	4' Sentry Elite housing 2 holes, 7/8"	35 pcs carton; 140 pcs pallet
LENS		
Part Number	Description	Packaging
4TFLSC5	4' Shallow low profile lens, impact modified clear acrylic	35 pcs carton; 210 pcs pallet
4TFLSL5	4' Shallow low profile lens, lumieo	35 pcs carton; 210 pcs pallet
4TFLSCC5	4' Shallow low profile lens, impact modified clear crepe acrylic	35 pcs carton; 210 pcs pallet
4SNGPG50	4' Parking garage lens, impact modified clear acrylic	35 pcs carton; 210 pcs pallet
4SNGPGPC	4' Parking garage lens, clear polycarbonate	35 pcs carton; 210 pcs pallet
4SNGPGLUM	4' Parking garage lens, lumieo	35 pcs carton; 210 pcs pallet
4SNGPGPC-F	4' Parking Garage Lens, Frosted Polycarbonate	35 pcs carton; 210 pcs pallet
4SNGPGPC-S	4' Parking Garage Lens, Frosted Polycarbonate 5VA	35 pcs carton; 210 pcs pallet
GEAR TRAY**		
Part Number	Description	Packaging
SENTGT4FB-LED	4' Sentry Elite Flat Gear Tray - 2 Row *****	TBD
SENTGT4P45CB	4' Sentry Elite Angled Gear Tray for Parking Garage - 2 Row *****	TBD
LED DRIVER GEAR TRAY**		
Part Number	Description	Packaging
SENTDT4-LED	4' Sentry Elite LED driver gear tray - 2 Row	TBD
SENTDT4-SR	4' Sentry Elite LED driver gear tray - 1 Row	TBD

Accessories

LATCHES***	
Part Number	Description
209383	Clear polycarbonate latch
LSNG-PC	White polycarbonate latch
LSNG-PCTP	Tamper-proof white polycarbonate latch with nut and screw
LSS-5	316 Stainless steel latch
LSS-5TP	Tamper-proof 316 stainless steel latch with nut and screw
TAMPER BIT 3	Driver bit for TAMPERPRUF screw used in LSNG-TP and LSS-5TP
WIRE ENTRY PLUGS	
Part Number	Description
FEPW	White 7/8" dry location plug
LTP088*	White 7/8" rubber plug
DC-2S*	7/8" die cast aluminum fitting assembly for 1/2" rigid conduit
HOUSING MOUNTING BRACKET OPTIONS	
Part Number	Description
SBRKT-SNG-2PK	316 SS strap bracket, 2-pack
HDW-SNG-KIT*****	Sentry Elite hardware kit
MISCELLANEOUS PARTS	
Part Number	Description
STANDOFF-SNG-2PK	Hex machined standoff with nut, 2-Pack
LANYARD	White nylon security strap

*Sealant required for wet location use.

**For custom hole/feature patterns, supply Order Sheet to BBS or Customer Service Representative.

***6 required per 2' SE hsg & 8 required per 4' SE hsg

***** Includes 2 each: MBRKT-SNG, HOOK-SNG, HBRKT-SNG, LOCKWASH-SNG, HEXNUT SS1428

***** Fits Bridgelux boards, EB Series

GEAR TRAYS

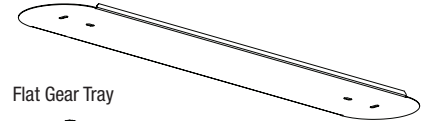

Flat Gear Tray

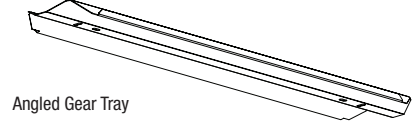

Angled Gear Tray

DRIVER TRAY

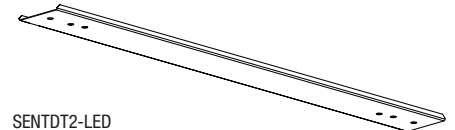

SENTDT2-LED

LATCHES



LSNG-PC
LSNG-PCTP



LSS-5
LSS-5TP

WIRE ENTRY PLUGS

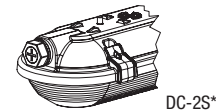

DC-2S*

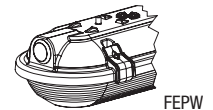

FEPW

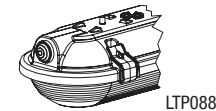

LTP088*

LENSES



Parking Garage

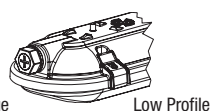

Low Profile

HOUSING MOUNTING BRACKETS

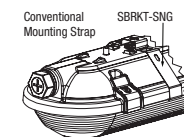

Conventional Mounting Strap

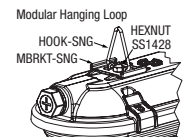

Modular Hanging Loop

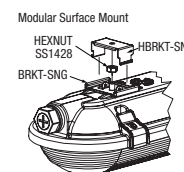

Modular Surface Mount

HEXNUT SS1428
HBRKT-SNG
BRKT-SNG

MISCELLANEOUS PARTS



STANDOFF-SNG-2PK



LANYARD

OPTIONAL ACCESSORIES



TAMPER BIT 3