

RDIALP2x4

Description

An attractive center basket 2x2 direct/indirect fluorescent fixture, the RDI provides soft, balanced illumination for a contemporary appearance and comfortable, low glare light.

The housing and lamp compartment are fully recessed above the ceiling plane, minimizing lamp exposure. The perforated baffle and curved reflector produce a combination of direct and indirect light, fully illuminating the fixture housing.

Applications

For use with standard 15/16" grid ceiling systems.

Features

- Product family features a range of performance options
- Center basket, ballast covers and reflectors can be switched out to improve efficiency
- Combined T5/T8 socket plates for better inventory management
- Built-in earthquake feature for added security
- Latch-free basket for easier mounting; no moving parts for improved reliability
- Unassembled component kits and fully assembled boxed units now offered
- Reflectors and ends feature specially formulated proprietary matte white paint to enhance efficiency

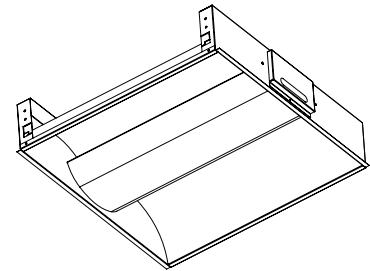

Housing

Die-formed heavy-gauge cold rolled steel

Basket Options

White perforated metal with white opal acrylic diffuser inlay or extruded white frosted acrylic

Ends and Socket Plates

Snap-in type. Biax socket plates available

Finish

Pre-painted white polyester polymer with minimum 82% reflectivity

Mounting

Standard troffer mounting for t-bar ceilings with earthquake feature

Lamps

1, 2 or 3-lamp T8 or T5 fluorescent, 1 to 6 Biax Lamps

Please contact A.L.P. for pricing and delivery.

All specifications subject to change without notice. A.L.P. assumes no responsibility for these materials in any luminaire or application.

The product is an OEM component kit requiring final assembly by a qualified OEM fixture manufacturer.

EXPLODED VIEW

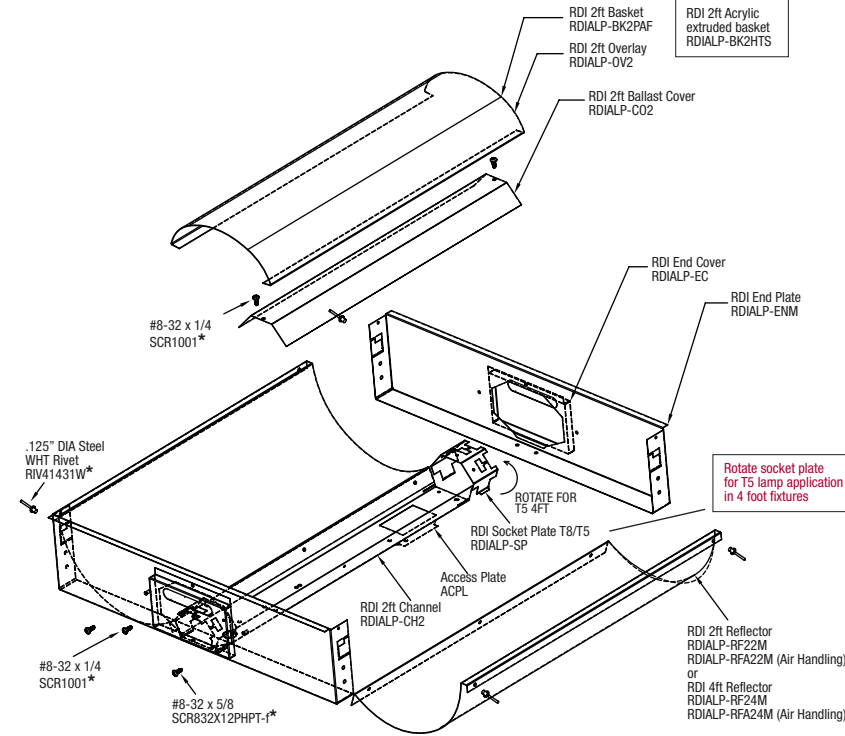

END VIEW

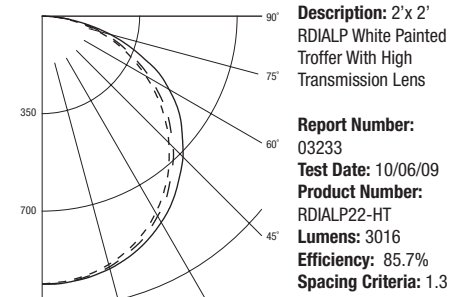
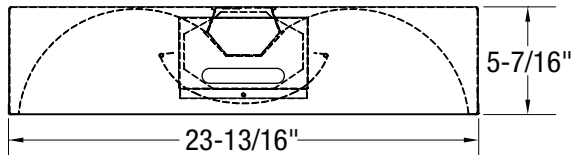

Zonal Lumen Summary

Zone	Lumens	%Lamp	%Fixt
0-30	760	21.6	25.2
0-40	1258	35.7	41.7
0-60	2285	64.9	75.7
0-90	3016	85.7	100.0
90-180	0	0.0	0.0
0-180	3016	85.7	100.0

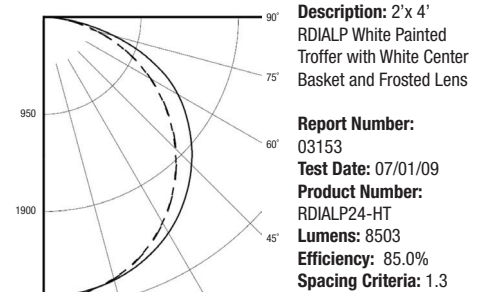

Zonal Lumen Summary

Zone	Lumens	%Lamp	%Fixt
0-30	2159	21.6	25.4
0-40	3568	35.7	42.0
0-60	6465	64.6	76.0
0-90	8503	85.0	100.0
90-180	0	0.0	0.0
0-180	8503	85.0	100.0

Ballast Installation Options

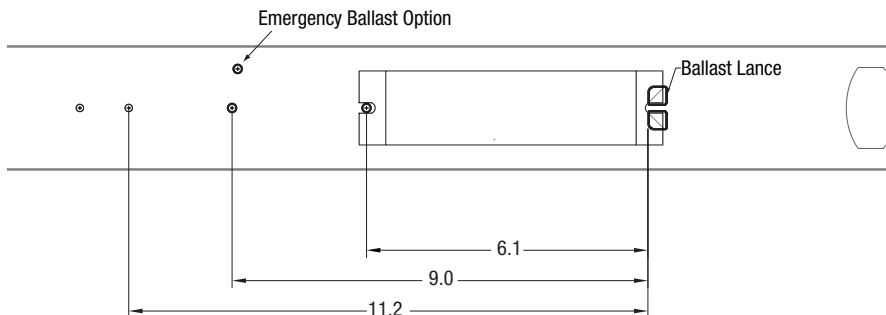

Notice

A.L.P. assumes no responsibility for suitability of these materials in any luminaire or application. Please test for fit and function prior to ordering project quantities.

While A.L.P. utilizes IESNA testing procedures and believes our testing results to be accurate, A.L.P. provides photometry for reference only. Actual results will vary based on the actual light source(s) and power source(s) used, i.e. ballast, driver, generator, etc. and the combinations in which they are used, as well as operating temperatures, and other electrical and environmental variables. We urge that customers perform their own fixture qualifications prior to making performance-based claims. In no event will A.L.P. be liable for any loss or damage, including without limitation, indirect or consequential loss or damage in connection with the use of this information.

2'x2' RDIALP KITS				
Catalog Number	Description	Lamps	Length	Socket Plate (QTY)
RDIALP22-LB	Perforated metal basket without high transmission lens, pre-painted matte white reflector	1,2,3 T8/T5	24"	RDIALP-SP (2)
RDIALP22-M	Perforated metal basket w/ white opal acrylic diffuser, pre-painted matte white reflector	1,2,3 T8/T5	24"	RDIALP-SP (2)
RDIALP22-HT	High transmission white frosted acrylic basket, pre-painted matte white reflector	1,2,3 T8/T5	24"	RDIALP-SP (2)
RDIALP22-BXHT	High transmission white frosted acrylic basket, pre-painted matte white reflector	1-6 BIAX	24"	RDIALP-SPBX (2)
RDIALP22-BXM	Perforated metal basket w/ white opal acrylic diffuser, pre-painted matte white reflector	1-6 BIAX	24"	RDIALP-SPBX (2)
RDIALP22A-M	Perforated metal basket w/ white opal acrylic diffuser, pre-painted matte white reflector and air handling slots	1,2,3 T8/T5	24"	RDIALP-SP (2)

2'x4' RDIALP KITS				
Catalog Number	Description	Lamps	Length	Socket Plate (QTY)
RDIALP24-LB	Perforated metal basket without high transmission lens, pre-painted matte white reflector	1,2,3 T8/T5	48"	RDIALP-SP (2)
RDIALP24-M	Perforated metal basket w/ white opal acrylic diffuser, pre-painted matte white reflector	1,2,3 T8/T5	48"	RDIALP-SP (2)
RDIALP24-HT	High transmission white frosted acrylic basket, pre-painted matte white reflector	1,2,3 T8/T5	48"	RDIALP-SP (2)
RDIALP24-BXHT	High transmission white frosted acrylic basket, pre-painted matte white reflector	1-6 BIAX	48"	RDIALP-SPBX (2)
RDIALP24-BXM	Perforated metal basket w/ white opal acrylic diffuser, pre-painted matte white reflector	1-6 BIAX	48"	RDIALP-SPBX (2)
RDIALP24A-M	Perforated metal basket w/ white opal acrylic diffuser, pre-painted matte white reflector and air handling slots	1,2,3 T8/T5	48"	RDIALP-SP (2)

Note: For assembled kits please add suffix "ASM" before the catalog number. Ex. ASMRDIALP24-M

RDIALP 2X2 COMPONENTS		
Catalog Number	Description	Qty
RDIALP-BK22PAF	RDI 2Ft Basket	1
RDIALP-OV2	RDI 2Ft Overlay	1
RDIALP-CO2	RDI 2Ft Ballast Cover	1
RDIALP-EC	RDI End Cover	2
RDIALP-ENM	RDI End Plate	2
ACPL	Socket Plate T5/T8	2
RDIALP-SPBX	RDI Biax Socket Plate	2
STLACPL4P	Access Plate	1
RDIALP-CH2	RDI 2Ft Channel	1
RDIALP-RF22M	RDI 2Ft Reflector	2
RDIALP-RFA22M	RDI 2Ft Reflector heat removal	2

RDIALP 2X4 COMPONENTS		
Catalog Number	Description	Qty
RDIALP-BK24PAF	RDI 4Ft Basket	1
RDIALP-OV4	RDI 4Ft Overlay	1
RDIALP-CO4	RDI 4Ft Ballast Cover	1
RDIALP-EC	RDI End Cover	2
RDIALP-ENM	RDI End Plate	2
ACPL	Socket Plate T5/T8	2
RDIALP-SPBX	RDI Biax Socket Plate	2
STLACPL4P	Access Plate	1
RDIALP-CH4	RDI 4Ft Channel	1
RDIALP-RF24M	RDI 4Ft Reflector	2
RDIALP-RFA24M	RDI 4Ft Reflector heat removal	2

Miscellaneous Parts (Parts not included in kit)			
Catalog Number	Description	Qty 2' Unit	Qty 4' Unit
SCR832X12PHPT-F	#832 x 5/8 Pan Head Phillips drive type f-point steel zinc finish	4	4
SCR1001	#832 x 1/4 Pan Head Phillips drive type f-point steel zinc finish	4	4
RIV41431W	.125" DIA multi grid steel white rivet	14	20

Lampholder Options

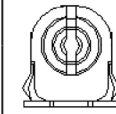
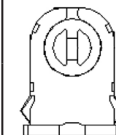
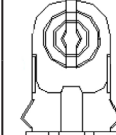
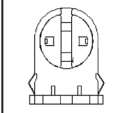
	Part Number	Description
	F1232T8-S	T8 rotary snap-in lampholder, rapid start ballast shunted, G13 medium bi-pin
	F1233T8-S	T8 rotary snap-in lampholder, instant start ballast non-shunted, G13 medium bi-pin
	F2010T8-S	T8 rotary snap-in lampholder, rapid start ballast shunted, G13 medium bi-pin
	F2001T8-S	T8 rotary snap-in lampholder, instant start ballast non-shunted, G13 medium bi-pin
	F2021T8-S	T8 rotary snap-in lampholder, rapid start ballast shunted, G13 medium bi-pin
	F2011T8-S	T8 rotary snap-in lampholder, instant start ballast non-shunted, G13 medium bi-pin
	F1501T5-S	T5 rotary snap-in lampholder G5 base, rapid start non shunted

Biax Lampholders

Source	Part Number (ALP)	Clip
Stucchi	F9042-S	Screw-on socket